

Product 1137 HQD 400/8/4

Image



Characteristics

Static pressure Pa

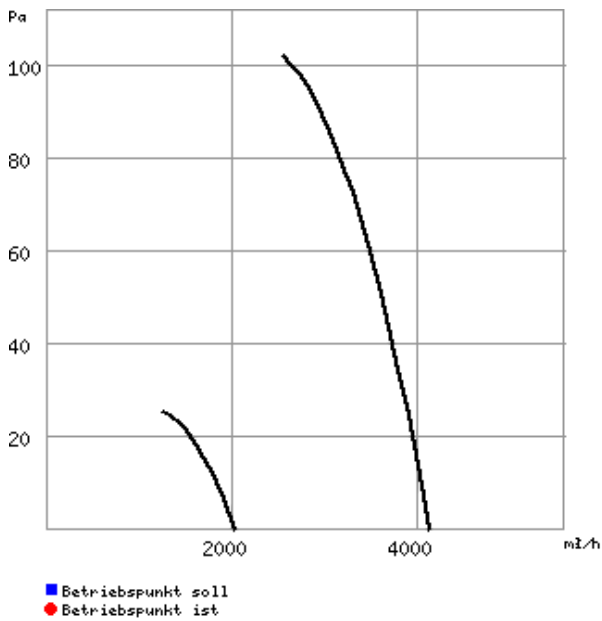

Air flow volume m³/h

Properties

Ref.no.	1137 - 021								
Model	HQD 400/8/4								
Description	High efficiency axial fan 3-ph., pole-switching, Dahlander windings with safety guard guard								
Actual pressure	static								
Actual volume									
Max. Vol.	4100 m³/h								
Speed	690 / 1390 min-1								
FLC un-controlled	0.25 / 0.60 A								
STC un-controlled	2.4 A								
Power	70 / 250 W								
Voltage	400 / 400 V / 3 ph / 50 / 50 Hz								
Max.temp.	60 °C								
Wiring diagram no.	472								
Weight	13.00 kg								
Delivery time	Ex stock								
Acoustic data:									
Sound in-duct	59 in 4 m								
Case breakout									
Intake	Hz	Total	125	250	500	1k	2k	4k	8k
Lwa Intake	dB(A)	79	65	69	76	72	70	65	56
Lwa Extract	dB(A)	0	0	0	0	0	0	0	0
Lwa Breakout	dB(A)	0	0	0	0	0	0	0	0

Description

HQD 400/8/4

High efficiency axial fan
3-ph., pole-switching, Dahlander windings
with safety guard guard









Square plate high efficiency axial fan with inlet cone, directly driven.

Square mounting plate with drawn bell mouth inlet and duct in galvanised sheet-steel and finished with two coats of paint.

Highly efficient, profiled blade impeller from polymers, aerodynamically optimised to the application, dynamically balanced. Suitable for -30 °C to +60 °C.

Totally enclosed, 3-phase squirrel cage motor, 2-speed (pole switching with Dahlander windings).
Maintenance free with low-noise sealed for life ball bearings.

Accessories

Image	Ref.no.	Model	Description	Group
	778	EVK 400	ELECTRICAL LOUVRE GRILLES CONTROL VIA RELAY (BY OTHERS)	A
	809	F 400	ADAPTION PLATE FOR GRILLE	A
	1293	M 3	FULL MOTOR PROTECTION UNIT FOR 3 PH POLE SWITCHING MOTORS WITH SEPARATE WINDINGS	A
	5081	PDA 12	POLE SWITCH FOR 3 PH MOTORS WITH DAHLANDER WINDINGS 400 V, 3-PH., MAX.12 A, IP 65	A
	1282	PWDA	REVERSING AND POLE SWITCH FOR 3 PH DAHLANDER MOTORS 400V, -3 PH., MAX. 25 A, IP 55	A
	754	RAG 400	RAIN-REPELLENT GRILLE	A
	1595	RHS 6+2	ISOLATOR SWITCH 6-POLE, 230-500 V, 25 A, IP 65 IP 65	A
	770	RVK 400	MANUAL GRILLE	A
	762	VK 400	GRAVITY OPERATED SHUTTER MADE FROM POLYMERS	A

Wiring diagram

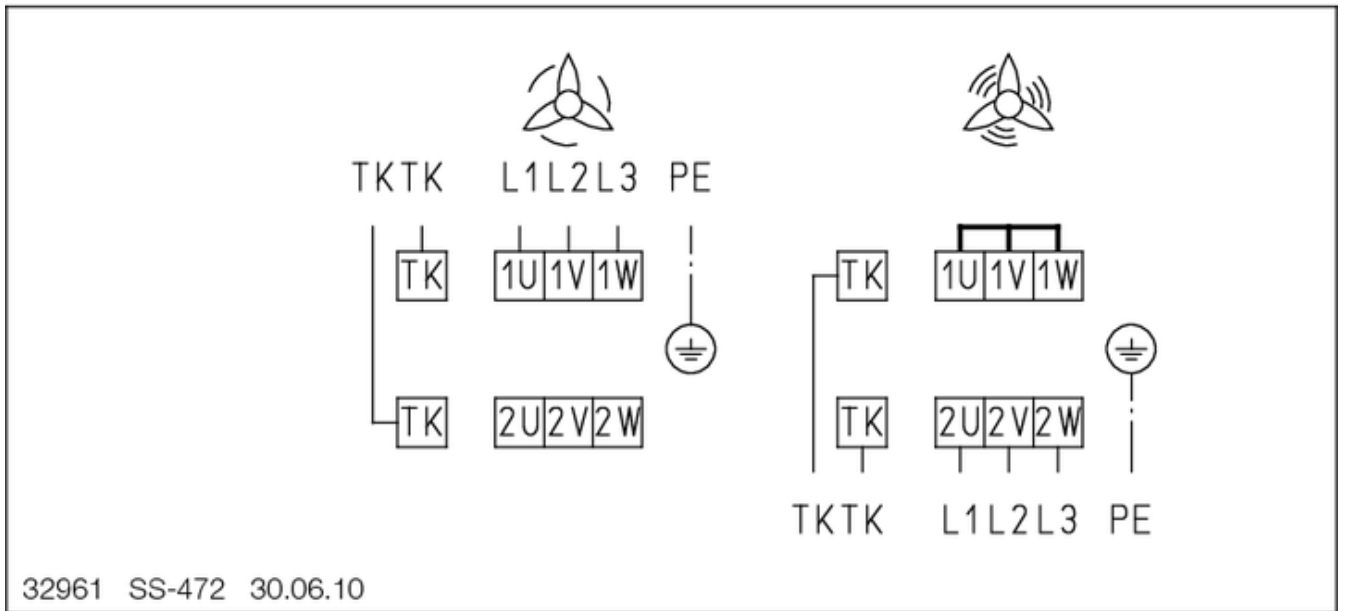

Dimensions

